

Article number: 53090104

Description: KLEE Hydraulic lubricating nipple DIN 71412
H1 straight, M6x1,0

Measures

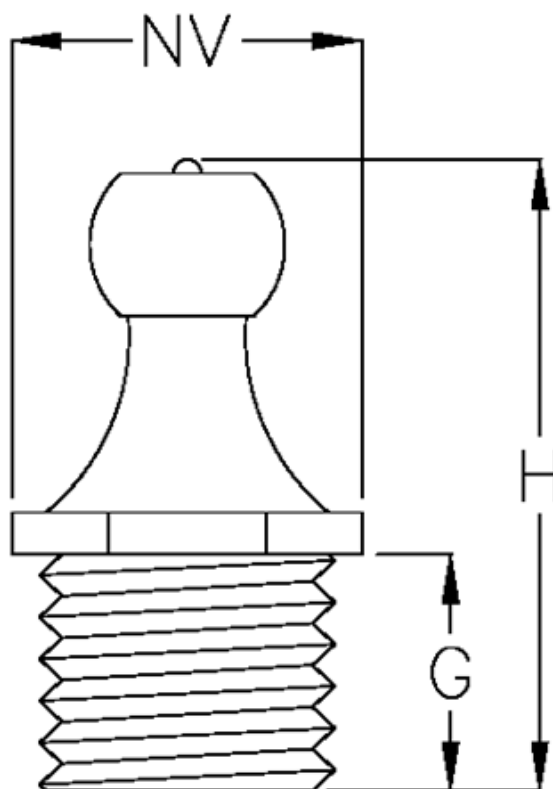

G = 6,2

H = 16

NV = 6,9

Thread = M6x1,0